

Specifications

Flood Light FL2A Series



Features

- Modular pluggable technology, easy-tool onsite maintenance;
- Honeycomb briquette burning effect and the whole structure cooling technology;
- Double-coupling IP68 protection for module, highest waterproof level;
- Ergonomic light distribution to achieve even illuminating effect;
- Free serialization and various power solutions.

Applications

- Football field, golf course, airport, wall wash, cross road ...



Contents

Special Technical Advantages of HPWINNER Modular Lights.....3

Electrical and Photometric Specification.....4

Mechanical and Environmental Specification.....4

Light Distribution.....5

Dimensions.....5





Installation.....6

Maintenance.....6

Ordering Information.....6

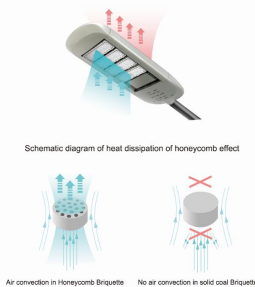

Special Technical Advantages of HPWINNER Modular Lights

 <p>Honeycomb Briquette effect It simulates and adopts the burning principle of honeycomb briquette; it is easy to transform the original block of radiator to various modules, as well as to enable air to convect and fully pass through the gaps between modules by utilizing the honeycomb effect, thus to remove the heat rapidly, and reduce temperature by around 20 °C.</p>	 <p>Heat dissipation of the whole structure It is available to make clever use of module bracket that only play a supporting role, and to transform it to a "thermal bracket" that is capable of conducting the module's heat to the light shell as a structural part, thus to promote the cooling effect of radiator of cooling module, the design aims to fully utilize the surface area of structural parts to transfer heat to air.</p>	 <p>Easy-tool maintenance It uses special structural design to achieve the manual disassembly and installation of lighting components, in consideration that the high-power lights are generally installed in higher operating environment, the operators require as few tools as possible for their convenience and security.</p>
 <p>Double-coupling IP68 protection It adopts the screw-free structure to avoid the penetration of water vapor through the screw hole; its double silicon-rubber rings insulate LEDs with the outside environment completely, thus to eliminate any erosion to chips and PCB boards from outside.</p>	 <p>High-eficacy LED Light source It adopts Philips lumileds LUXEON T LED source with super efficacy and light output from a compat source. Optimized for efficacy driven applications with typical Vf: 2.7V and low thermal resistance: 3K/W. Specified, targeted and tested hot, at real world operating temperatures, Tj=85°C to ensure in- application performance.</p>	 <p>Free Serialization It is available to freely equip with different numbers of modules to achieve different powers as required.</p>

Electrical and Photometric Specification

Model	Input Voltage (V)	Driving Current (mA)	Power (W)	Luminous Efficacy (lm/W)	Flux (lm)	Power Factor	Power Efficiency	Beam Angle	LED Brand	CCT (K)	CRI
FL2A-1	AC100-277	700	40	100±5	4000±200	0.95	89%	12° 25° 40° 60°90°	Philips Lumileds Luxeon TX	3000,4000, 5000,5700	>70
		860	50	95±5	4750±250						
		1050	60	90±5	5400±300						
FL2A-2	AC100-277	700	80	100±5	8000±400	0.95	91%	12° 25° 40° 60°90°	Philips Lumileds Luxeon TX	3000,4000, 5000,5700	>70
		860	100	95±5	9500±500						
		1050	120	90±5	10800±600						
FL2A-3	AC100-277	700	120	100±5	12000±600	0.95	91%	12° 25° 40° 60°90°	Philips Lumileds Luxeon TX	3000,4000, 5000,5700	>70
		860	150	95±5	14250±750						
		1050	180	90±5	16200±900						

Mechanical and Environmental Specification

Model	Working Environment	Storage Temperature	Lumen Maintenance (h)	Housing Material	Surge Protection	Product Size (mm)	Packing Size (mm)	N.W (kg)	G.W (kg)
FL2A-1	-40℃~+50℃, 10%~90%RH	-40℃~+50℃	>50000	Aluminum Alloy	10KV	285*110*287	390*165*190	2.5	3
FL2A-1 (1.05A)						290*120*287	390*180*190	3.2	3.8
FL2A-2						285*190*287	390*245*190	4	4.6
FL2A-3						285*270*287	390*325*190	5.3	6.1

Light Distribution

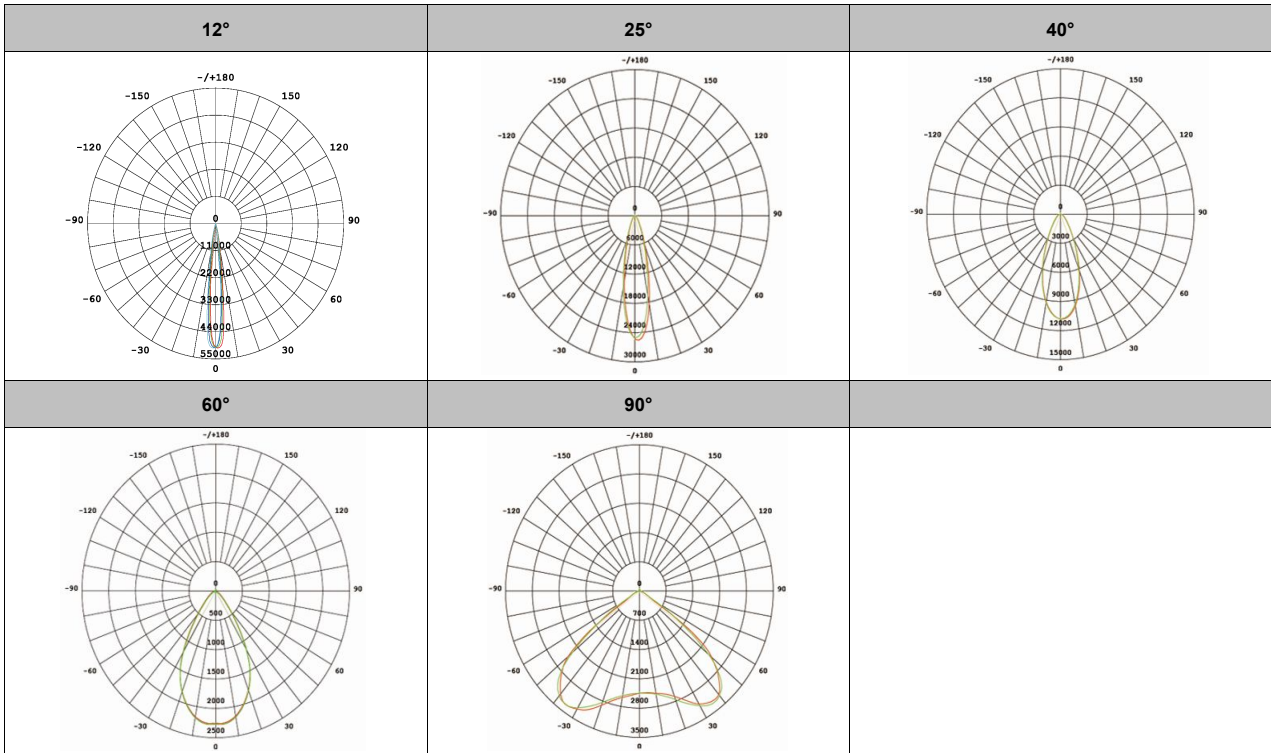

Dimensions

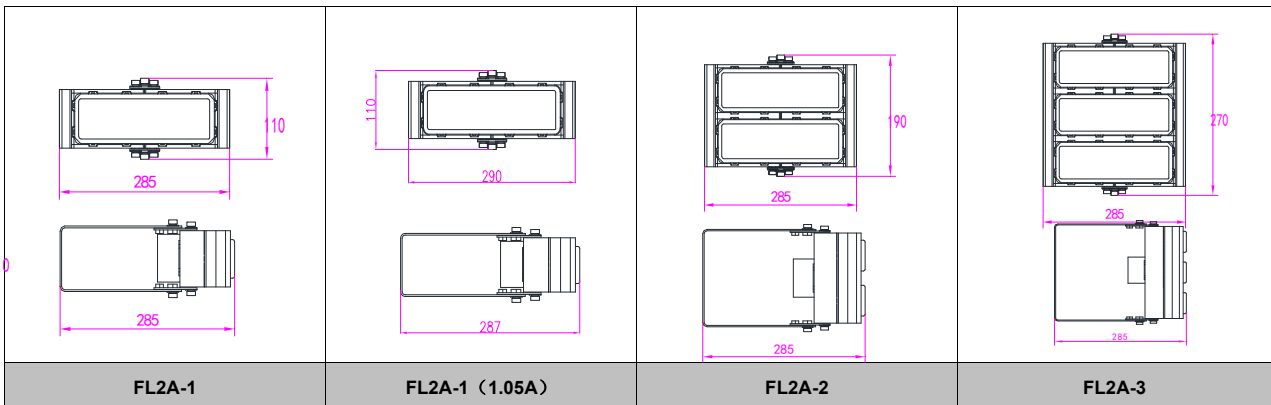

Installation

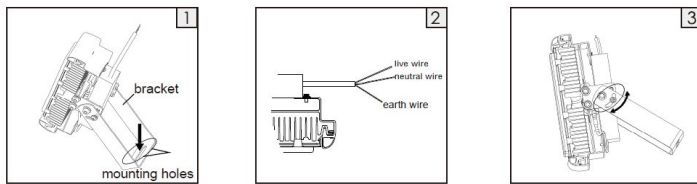

- Step 1:** Mount the light to the wall with screws at the mounting holes on the bracket;
Step 2: Connect the wires to the AC wires. (The earth wire should be reliable and linked to the ground);
Step 3: Adjust the angle of the bracket (see Instructions on Adjustable Mounting Bracket in appendix).

Maintenance

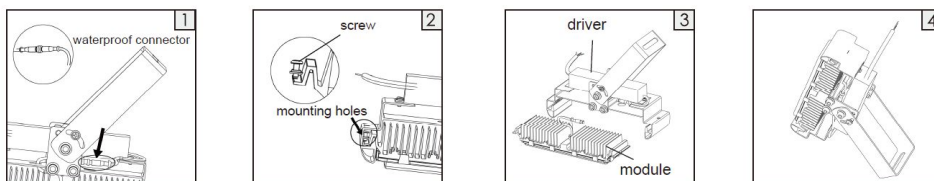

- Step 1:** Disconnect the waterproof connectors;
Step 2: Loosen the screws at both ends of the failed module(s)/driver(s);
Step 3: Replace the failed module(s)/ driver(s) with qualified one(s);
Step 4: Tighten up the screws at both ends of the module(s)/driver(s) and the waterproof connector.

Ordering Information

Model	Qty of modules	Watt	CCT	Colors	Beam Angle	Power Cord
FL2A	1 2 3	40/50/60 80/100/120 120/150/180	30=3000K 40=4000K 50=5000K 57=5700K	BK=Black GY=Gray	1=12° 2=25° 3=40° 4=60° 5=90°	A=America Standard E=European Standard U=Australia Standard O=Other requirements