

Applications

- Roadway lighting
(Underground passages, residential areas, overpasses...)
- Public areas lighting
(Theme parks, squares...)

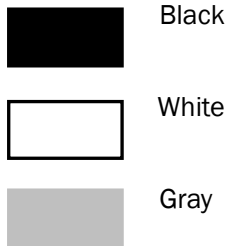

Standard Colors



Features

- Easy installation with hold hoop, elevation of 20 degree;
- All metal structure design, built-in driver;
- Double-coupling IP68 protection for optics set, highest waterproof level;
- Photocontrol equipped for better energy-saving performance;
- Ergonomic lighting distribution to achieve uniform illuminating effect.



Electrical & Photometric

Model	Input Voltage (V) Frequency Range (Hz)	Drive Current (mA)	Power (w)	Luminous Efficacy (lm/w)	Lumens (lm)	Power Factor	Power Efficiency	Light Distributions	LED Brand	CCT (k)	CRI
T1K	AC100-240 50/60	370	20	140±8	2800±160	0.95	85%	Batwing (Type II)	Customized	3000 ^①	≥70
		650	35	123±8	4305±280	0.95	88%		Chips from World-leading Supplier	4000 5000 5700	

① Luminous efficacy of 3000K is 5% lower than other CCTs.

Working environment & Packing

Model	Working Environment	Storage Temperature	Surge Protection	IP Rating	LED Life Span (h)	Housing Material	Product Dimensions (mm)	Outer Carton Size (mm)	N.W (kg)	G.W (kg)
T1K	-40°C~+50°C, 10%~90%RH.	-40°C~+50°C	15KV	Whole Fixture IP67	>50,000	Aluminum Alloy	380*125*105	405*175*150 (Inner Carton) ^① 900*420*315 (Master Carton) ^②	1.8	2.0 (Inner Carton) 21.5 (Master Carton)

① Inner carton is the separate packing of 1 unit T1K.

② Master carton include 10pcs inner cartons.

Warranty

5-year limited warranty is standard on luminaire and components.

Light Distributions

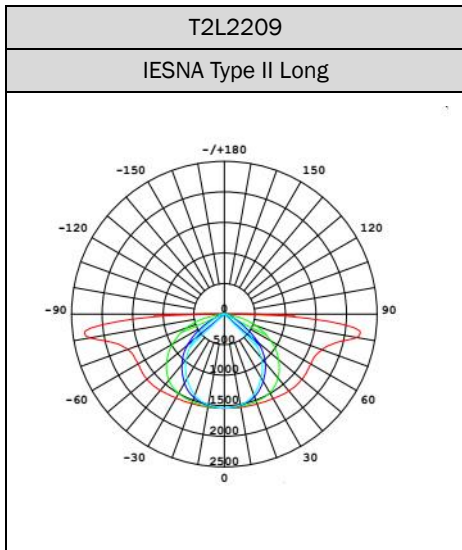

Design Features

Front View



Back View



Dimensions

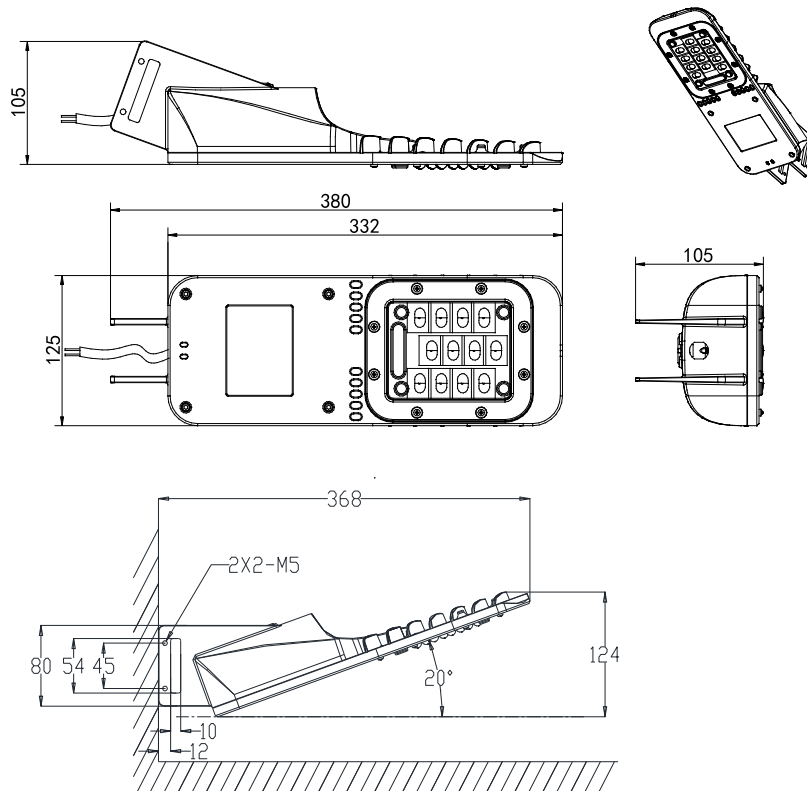

Installation

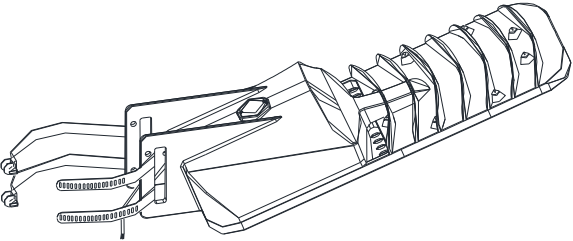
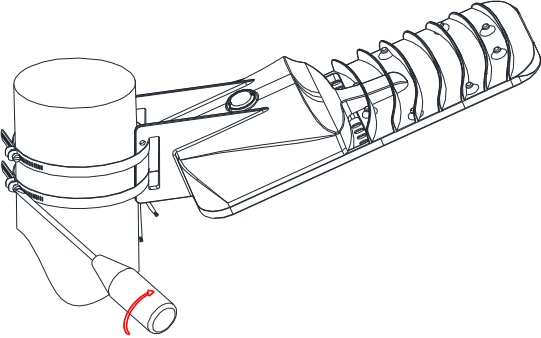
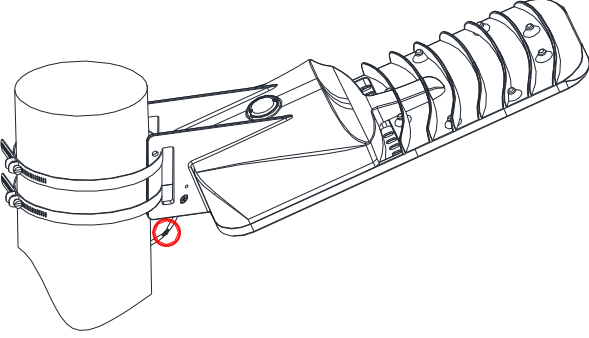
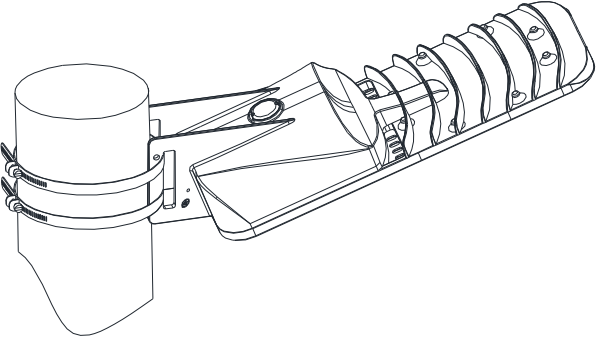
	
<p>1. Pass the hold hoops through the installation hole.</p>	<p>2. Fixate the hold hoops to the pole. Do the hold hoop screws clockwise.</p>
	
<p>3. Connect the wires to the live, neutral and ground wire of the AC input (make sure it grounded sufficiently).</p>	<p>4. Installation finished.</p>

*The hold hoop is optional accessories, actual installation to be matched on the received product without notice.

Revision History

Change Date	Rev.	Description of Change		
		Item	From	To
2016/06/17	Rev1.0	Datasheets Release		
2016/09/08	Rev1.1	Data of 20W		Added
2016/11/10	Rev1.2	Data of Luminous Efficacy		Modification